

PRESCOT

LED POWER SUPPLIES

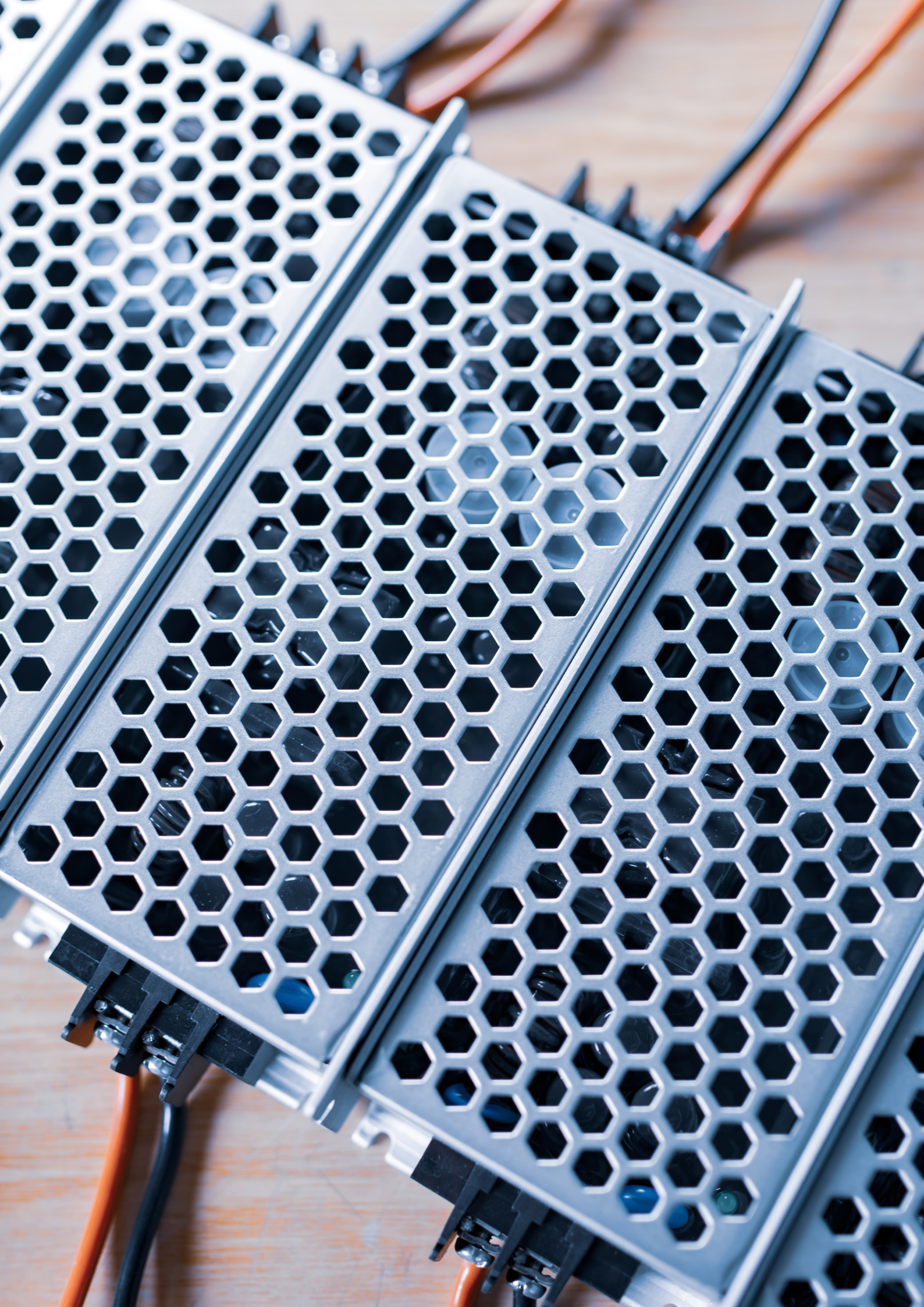



HERMETIC ROUND





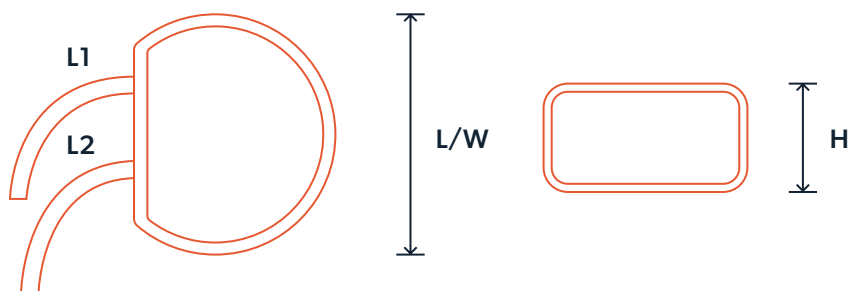







									
CATALOG NO.	OUTPUT VOLTAGE [V]	INPUT VOLTAGE [V]	POWER [W]	CURRENT [A]	L1 WIRE [cm]	L2 WIRE [cm]	DIMENSION LxWxH [MM]	PROTECTION	EAN
IP-10-12-O	12	230	10	0,83	14	14	58x58x25	IP67	5901885262536
IP-15-12-O	12	230	15	1,25	14	14	58x58x25	IP67	5901885262543
IP-20-12-O	12	230	20	1,67	14	14	58x58x25	IP67	5901885262550
IP-10-24-O	24	230	10	0,41	14	14	58x58x25	IP67	5901885262581
IP-15-24-O	24	230	15	0,625	13	13	58x58x25	IP67	5901885265575
IP-20-24-O	24	230	20	0,83	14	14	58x58x25	IP67	5901885265582











HERMETIC



									
CATALOG NO.	OUTPUT VOLTAGE [V]	INPUT VOLTAGE [V]	POWER [W]	CURRENT [A]	L1 WIRE [cm]	L2 WIRE [cm]	DIMENSION LxWxH [MM]	PROTECTION	EAN
IP-10-12	12	230	10	0,83	13	13	115x28x21	IP67	5902596558680
IP-10-12A	12	220	10	0,83	16	16	100x30x20	IP67	5903684855209
IP-15-12	12	220	15	1,25	13	13	162x29x21	IP67	5902596558673
IP-15-12A	12	220	15	1,25	15	17	100x30x20	IP67	5903684855216
IP-20-12	12	220	20	1,67	13	13	162x29x21	IP67	5901885267227
IP-20-12A	12	220	20	1,67	16	17	112x30x20	IP67	5903684855223
IP-30-12	12	220	30	2,5	13	13	192x29x21	IP67	5901885267234
IP-30-12A	12	220	30	2,5	18	18	142x30x20	IP67	5903684855230
IP-45-12	12	220	45	3,75	12	12	207x35x24	IP67	5901885267241
IP-60-12	12	220	60	5	22	22	165x46x25	IP67	5901885267258
IP-80-12	12	220	80	6,67	2x18	18	189x69x43	IP67	5901885262567
IP-100-12	12	220	100	8,33	2x18	20	189x69x43	IP67	5902596558826

HERMETIC



									
CATALOG NO.	OUTPUT VOLTAGE [V]	INPUT VOLTAGE [V]	POWER [W]	CURRENT [A]	L1 WIRE [cm]	L2 WIRE [cm]	DIMENSION LxWxH [MM]	PROTECTION	EAN
IP-150-12	12	220	150	12,5	2x19	17	251x68x43	IP67	5901885267265
IP-200-12	12	220	200	16,7	3x19	19	235x125x60	IP67	5901885260532
IP-200-12A	12	220	200	16,7	2x18	17	192x65x40	IP67	5903684855247
IP-250-12	12	220	250	20,83	3x18	20	250x74x52	IP67	5901885265551
IP-300-12	12	220	300	25	3x18	20	250x74x52	IP67	5901885265568
IP-10-24	24	220	10	0,41	13	13	115x28x21	IP67	5901885262574
IP-10-24A	24	220	10	0,41	13	13	100x30x20	IP67	5903684855254
IP-15-24	24	220	15	0,63	14	18	162x29x21	IP67	5901885262598
IP-15-24A	24	220	15	0,63	16	16	100x30x20	IP67	5903684855261
IP-20-24	24	220	20	0,83	13	13	162x29x21	IP67	5901885262604
IP-30-24	24	220	30	1,25	13	13	201x35x24	IP67	5901885262611
IP-45-24	24	220	45	1,87	20	18	203x35x24	IP67	5901885265599

HERMETIC



CATALOG NO.	OUTPUT VOLTAGE [V]	INPUT VOLTAGE [V]	POWER [W]	CURRENT [A]	L1 WIRE [cm]	L2 WIRE [cm]	DIMENSION LxWxH [MM]	PROTECTION	EAN
IP-45-24A	24	220	45	1,87	18	17	162x40x23	IP67	5903684855278
IP-60-24	24	220	60	2,5	22	22	165x46x25	IP67	5901885262673
IP-100-24	24	220	100	4,17	2x18	18	188x69x43	IP67	5901885262680
IP-150-24	24	220	150	6,25	2x18	18	260x68x42	IP67	5901885262697
IP-150-24A	24	220	150	6,25	2x21	22	235x123x60	IP67	5903684855285
IP-200-24	24	220	200	8,33	3x18	18	235x123x60	IP67	5901885262703
IP-250-24	24	220	250	10,41	3x18	18	236x123x60	IP67	5901885265605
IP-300-24	24	220	300	12,5	3x18	18	235x123x60	IP67	5901885265612



MODULAR



								
CATALOG NO.	OUTPUT VOLTAGE [V]	INPUT VOLTAGE [V]	POWER [W]	CURRENT [A]	DIMENSION LxWxH [mm]	PROTECTION	OUTPUT VOLTAGE CONTROL	EAN
PR-15-12	12	220	15	1,25	70x40x31	IP20	YES	5901885262727
PR-15-12A	12	220	15	1,25	70x40x31	IP20	-	5903684855292
PR-25-12	12	220	25	2,1	85x58x32	IP20	YES	5901885262734
PR-38-12	12	220	38	3,2	85x58x32	IP20	YES	5901885262741
PR-50-12	12	220	50	4,2	111x78x36	IP20	YES	5901885262758
PR-50-12A	12	220	50	4,2	111x78x36	IP20	-	5903684855308
PR-60-12	12	220	60	5	111x78x36	IP20	YES	5901885262765
PR-75-12	12	220	75	6,25	111x78x36	IP20	YES	5901885262772
PR-75-12A	12	220	75	6,25	111x78x36	IP20	-	5903684855315
PR-100-12	12	220	100	8,3	159x98x42	IP20	YES	5901885262789
PR-150-12	12	220	150	12,5	198x98x42	IP20	YES	5901885262796

MODULAR



CATALOG NO.	OUTPUT VOLTAGE [V]	INPUT VOLTAGE [V]	POWER [W]	CURRENT [A]	DIMENSION LxWxH [mm]	PROTECTION	OUTPUT VOLTAGE CONTROL	EAN
PR-200-12	12	220	200	16,7	198x98x42	IP20	YES	5901885262802
PR-200-12A	12	220	200	16,7	198x98x42	IP20	-	5903684855322
PR-250-12	12	220	250	20,8	198x98x42	IP20	YES	5901885262819
PR-360-12	12	220	360	30	215x113x50	IP20	YES	5901885262826
PR-15-24	24	220	15	0,63	70x40x31	IP20	YES	5901885262833
PR-25-24	24	220	25	1	85x58x32	IP20	YES	5901885262840
PR-38-24	24	220	38	1	85x58x32	IP20	YES	5901885262857
PR-50-24	24	220	50	1,6	111x78x36	IP20	YES	5901885262864
PR-60-24	24	220	60	2,5	111x78x36	IP20	YES	5901885262871
PR-75-24	24	220	75	3,12	111x78x36	IP20	YES	5901885262888
PR-100-24	24	220	100	4,2	159x98x42	IP20	YES	5901885262895

MODULAR



CATALOG NO.	OUTPUT VOLTAGE [V]	INPUT VOLTAGE [V]	POWER [W]	CURRENT [A]	DIMENSION LxWxH [mm]	PROTECTION	OUTPUT VOLTAGE CONTROL	EAN
PR-150-24	24	220	150	6,25	198x98x42	IP20	YES	5901885262901
PR-200-24	24	220	200	8,33	198x98x42	IP20	YES	5901885262918
PR-250-24	24	220	250	10,4	198x98x42	IP20	YES	5901885262925
PR-360-24	24	220	360	15	215x113x50	IP20	YES	5901885262932

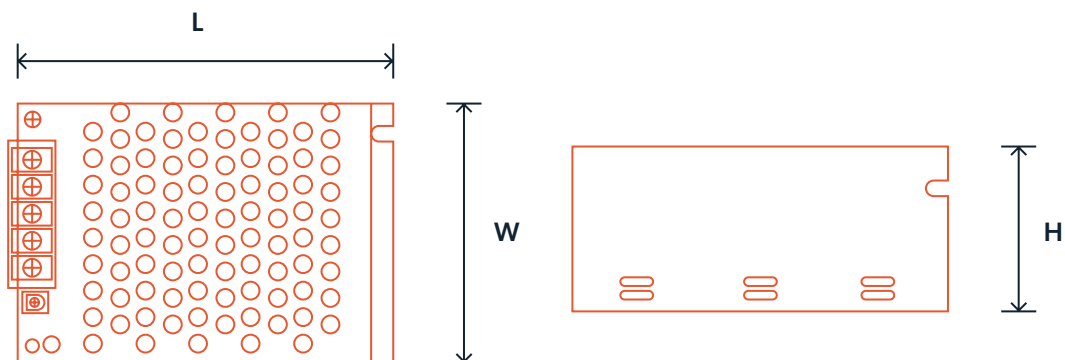

DESKTOP



CATALOG NO.	OUTPUT VOLTAGE [V]	INPUT VOLTAGE [V]	POWER [W]	CURRENT [A]	L1 WIRE [cm]	L2 WIRE [cm]	DC CONNECTOR	DIMENSION LxWxH [MM]	PROTECTION	EAN
PD-12-12/2.1	12	220	12	1	25	90	5,5/2,1	75x50x27	IP44	5901885263021
PD-24-12/2.1	12	220	24	2	25	90	5,5/2,1	110x50x30	IP44	5901885263038
PD-24-12/2.5	12	220	24	2	145	90	5,5/2,5	110x50x30	IP44	5901885263045
PD-36-12/2.1	12	220	36	3	145	110	5,5/2,1	110x50x30	IP44	5901885263069
PD-36-12/2.5	12	220	36	3	145	110	5,5/2,5	110x50x30	IP44	5901885263076
PD-60-12/2.1	12	220	60	5	119	90	5,5/2,1	118x50x32	IP44	5901885263083
PD-60-12/2.5	12	220	60	5	110	85	5,5/2,5	118x50x32	IP44	5901885263090
PD-72-12/2.1	12	220	72	6	110	85	5,5/2,1	131x56x32	IP44	5901885263106
PD-72-12/2.5	12	220	72	6	110	85	5,5/2,5	131x56x32	IP44	5903684851454
PD-96-12/2.1	12	220	96	8	110	85	5,5/2,1	132x60x34	IP44	5901885268330

DESKTOP



CATALOG NO.	OUTPUT VOLTAGE [V]	INPUT VOLTAGE [V]	POWER [W]	CURRENT [A]	L1 WIRE [cm]	L2 WIRE [cm]	DC CONNECTOR	DIMENSION LxWxH [MM]	PROTECTION	EAN
PD-120-12/2.1	12	220	120	10	110	105	5,5/2,1	168x63x38	IP44	5901885268347
PD-24-24/2.1	24	220	24	1	110	90	5,5/2,1	110x50x30	IP44	5901885268286
PD-60-24/2.1	24	220	36	2	110	90	5,5/2,1	118x50x32	IP44	5901885268316
PD-72-24/2.1	24	220	72	3	110	85	5,5/2,1	131x56x32	IP44	5901885268323

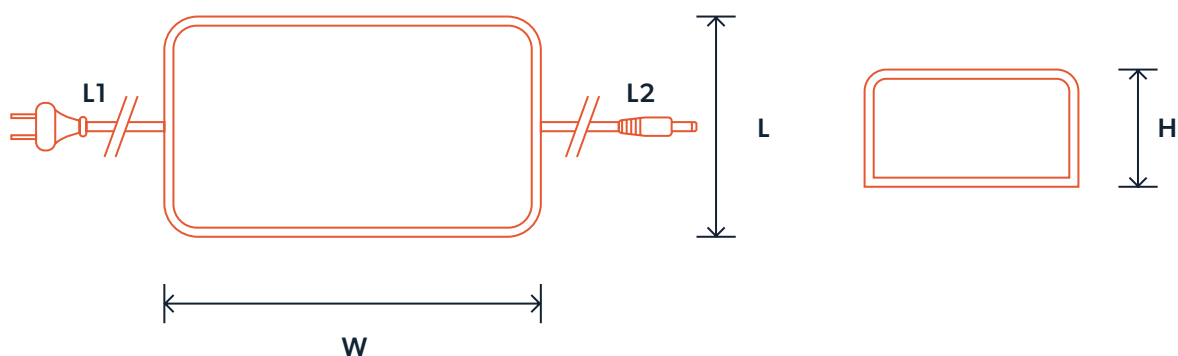

SOCKET



CATALOG NO.	OUTPUT VOLTAGE [V]	INPUT VOLTAGE [V]	POWER [W]	CURRENT [A]	L1 WIRE [cm]	DC CONNECTOR	COLOR	DIMENSION LxWxH [MM]	PROTECTION	EAN
PG-5V-550-USB	5	220	12	1	Not included	USB	black	74x40x30	IP44	5901885267432
PG-5V-1000-USB	5	220	24	2	Not included	USB	black	74x40x30	IP44	5903684850419
PG-6-5/2.1	5	220	24	2	110	5,5/2,1	black	74x40x30	IP44	5903684852017
PG-6-12/2.1	12	220	36	3	110	5,5/2,1	black	74x40x30	IP44	5901885263113
PG-6-12/2.1W	12	220	36	3	110	5,5/2,1	white	74x40x30	IP44	5903684850372
PG-6-12/2.5	12	220	60	5	110	5,5/2,5	black	74x40x30	IP44	5901885263120
PG-12-12/2.1	12	220	60	5	110	5,5/2,1	black	74x40x30	IP44	5901885263137
PG-12-12/2.1W	12	220	72	6	110	5,5/2,1	white	74x40x30	IP44	5903684850389
PG-12-12/2.5	12	220	72	6	110	5,5/2,5	black	74x40x30	IP44	5901885263144
PG-18-12/2.1	12	220	96	8	92	5,5/2,1	black	74x40x30	IP44	5901885263151
PG-18-12/2.5	12	220	18	1,5	92	5,5/2,5	black	74x40x30	IP44	5901885263168
PG-24-12/2.1	12	220	24	2	115	5,5/2,1	black	88x44x32	IP44	5901885263175
PG-24-12/2.1W	12	220	24	2	115	5,5/2,1	white	88x44x32	IP44	5903684850396

SOCKET



CATALOG NO.	OUTPUT VOLTAGE [V]	INPUT VOLTAGE [V]	POWER [W]	CURRENT [A]	L1 WIRE [cm]	DC CONNECTOR	COLOR	DIMENSION LxWxH [MM]	PROTECTION	EAN
PG-24-12/2.5	12	220	24	2	85	5,5/2,5	black	88x44x32	IP44	5901885263182
PG-24-12/2.5W	12	220	24	2	110	5,5/2,5	white	88x44x32	IP44	5903684851478
PG-36-12/2.1	12	220	36	3	110	5,5/2,1	black	88x51x31	IP44	5901885263199
PG-36-12/2.5	12	220	36	3	110	5,5/2,5	black	88x51x31	IP44	5901885263205
PG-24-24/2.1	24	220	24	1	92	5,5/2,1	black	88x44x32	IP44	5901885263212
PG-24-24/2.5	24	220	24	1	90	5,5/2,5	black	88x44x32	IP44	5901885263229
PG-36-24/2.1	24	220	36	1,5	85	5,5/2,1	black	88x51x31	IP44	5901885263236
PG-36-24/2.5	24	220	36	1,5	92	5,5/2,5	black	88x51x31	IP44	5901885263243

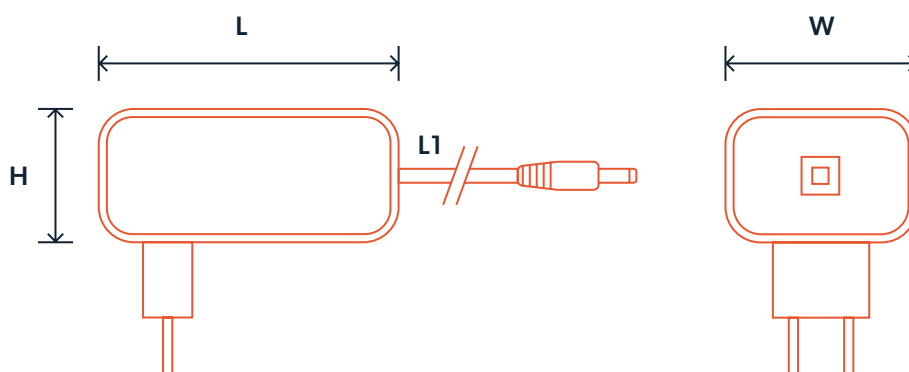

PRESCOT LED

PRESCOT Sp. z o.o.

Wilenska 1, 11-500 Gizycko

Telephone: +48 87 428 21 18

Fax: +48 87 428 17 09

komponenty@prescot.pl

www.prescot.pl